

Classroom Audio System



User Manual

CONGRATULATIONS!



Congratulations on your purchase of the 850iR Classroom Audio System! This simple, yet powerful technology provides crystal-clear sound throughout the classroom, allowing every child to hear every word every time.

As the teacher speaks into the REDMIKE™ classroom microphone, his or her voice is transmitted to the 850iR and then amplified through the loudspeaker(s). The standard system includes the 850iR infrared receiver/ amplifier, REDMIKE classroom microphone, SR-70F infrared sensor and speaker package.

The 850iR is a two-channel receiver amplifier that allows the use of up to two microphones simultaneously and up to three additional audio input sources (such as TV, VCR, DVD, CD, MP3, etc.). In addition, Lightspeed offers various speaker options that are included with your system to provide optimal sound in rooms of all shapes and sizes.

The REDMIKE is a wireless, pendant-style transmitter. This two-channel, rechargeable unit is clipped to a lavalier cord and worn around the neck for teacher use, or it can be used like a standard handheld microphone for the students to pass around when speaking.

SAFETY INSTRUCTIONS AND CERTIFICATIONS

**CAUTION****RISK OF ELECTRIC SHOCK DO NOT OPEN**

**CAUTION: TO REDUCE THE RISK OF ELECTRIC SHOCK
DO NOT REMOVE COVER (OR BACK)**

NO USER-SERVICEABLE PARTS INSIDE

REFER SERVICING TO QUALIFIED PERSONNEL

The lightning flash with arrowhead symbol within an equilateral triangle is intended to alert the user to the presence of uninsulated "dangerous voltage" within the product's enclosure, that may be sufficient magnitude to constitute a risk of electric shock.



The exclamation point within an equilateral triangle is intended to alert the user to the presence of important operating and maintenance (servicing) instructions in the literature accompanying the appliance.

**CERTIFICATIONS**

Complies with 72/23/EEC Low Voltage Directive and 89/336/EEC Electromagnetic Compatibility Directive. Compliance was demonstrated to the following specifications as listed in the Official Journal of the European Union:

EN 60950: Electrical Safety – A1:1993, A2:1993, A3:1993, A4:1997

EN 55022: RF Emissions, Information Technology Equipment

EN 55024: EMC Immunity Standard

EN 61000-3-2: Harmonics

EN 61000-3-3: Voltage Fluctuation



Lightspeed Technologies launched a formal product recycle program in Europe that complies with the European Union Directive 2002/96/EC on Waste Electrical and Electronic Equipment ("WEEE Directive"). Please visit our website at www.Lightspeed-tek.com for more information.



This product is manufactured using lead-free processes and is free of other materials harmful to the environment. It conforms to the most stringent new European guidelines for consumer products (RoHS).



Lightspeed is proud to inform that the REDCAT RCP has achieved the ENERGY STAR® label. ENERGY STAR qualified products save you money by reducing energy costs and helps protect the environment without sacrificing features or performance.

- 1. Read Instructions**—All safety and operation instructions should be read before this Lightspeed product is operated.
- 2. Retain Instructions**—The safety and operating instructions should be kept for future reference.
- 3. Heed Warnings**—All warnings on this Lightspeed product and in these instructions should be followed.
- 4. Follow Instructions**—All operating and other instructions should be followed.
- 5. Water and Moisture**—This Lightspeed product should not be used near water.
- 6. Heat**—This Lightspeed product should be situated away from heat sources such as radiators, etc.
- 7. Power Sources**—This Lightspeed product should be connected to a power supply only of the type described in the operation instructions or as marked on this Lightspeed product.
- 8. Power Cord Protection**—Power supply cords should be routed so that they are not likely to be walked upon or pinched by items placed upon or against them.
- 9. Object and Liquid Entry**—Care should be taken so that objects do not fall onto and liquids are not spilled into the Lightspeed product.
- 10. Damage Requiring Service**—This Lightspeed product should be serviced only by qualified service personnel. The user should not attempt to service this Lightspeed product.
- 11. Prevent Electric Shock**—Do not use this polarized plug with an extension cord, receptacle or other outlet unless the blades can be fully inserted to prevent blade exposure.

TABLE OF CONTENTS

850iR CLASSROOM AUDIO SYSTEM

Safety Instructions and Certifications	ii
SECTION 1: System Overview	1
System Components	2
Front Panel Controls.....	3
Rear Panel Controls	4
Page First: Emergency Page Priority	4
REDMIKE Controls and Connections	6
Attaching the Lanyard to REDMIKE.....	7
Cradle Charger Controls and Connections	8
Optional LT-71 Controls and Connections.....	9
Optional HM-70 Controls and Connections	10
SECTION 2: Installation	11
Unpacking Your System	12
Location of the Receiver/Amplifier.....	13
IR Sensor Installation.....	14
Suspended Ceiling Mount.....	15
Wall/Solid Ceiling Mount.....	15
Speaker Installation.....	16
Audio Integration	17
Finalizing Connections	19
Final Check	20
SECTION 3: Initial Set-up, Charging and Optional Features	21
Initial Set-Up: REDMIKE	22
Initial Set-Up: Optional LT-71	23
Initial Set-Up: Optional HM-70	24
Charging the REDMIKE	25
Charging the Optional LT-71	26
Charging the Optional HM-70	27
Output to Personal FM Transmitter	28
Using the REDMIKE to Amplify External Audio Equipment.....	29
SECTION 4: Troubleshooting, Daily Use and Warranty	30
Troubleshooting Guide.....	31
Daily Use Instructions.....	32
Tips on Classroom Audio	33
Warranty Statement.....	33
System Specifications	34
Individual Components and Optional Accessories	35
User Notes.....	36

SECTION 1

System Overview

SYSTEM COMPONENTS

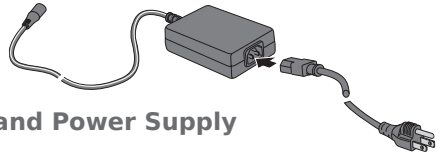

850iR Infrared Receiver/Amplifier and Power Supply

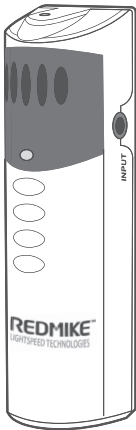

REDMIKE Classroom Microphone

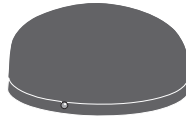

SR-70F Infrared Sensor

Sensor Cable



Charging Cradle and Power Supply

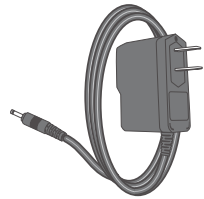
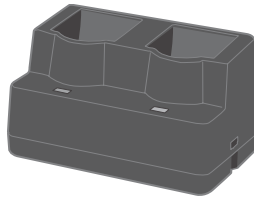

Speakers and Speaker Wire

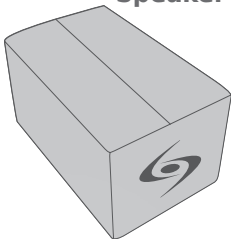

Optional LT-71 LightMic and Charger Cable

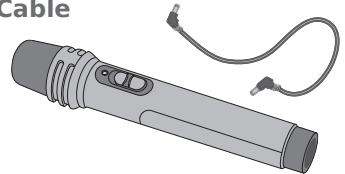
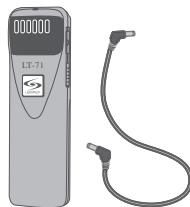

Optional HM-70 Handheld Microphone and Charger Cable



Helpful Hint

Keep ALL packaging materials. If the system must be returned, using the original packing material will be quick, convenient and prevent damage.

FRONT PANEL CONTROLS

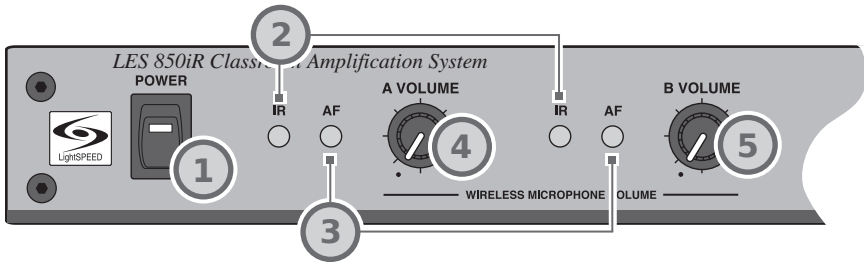
**1. POWER Switch/POWER Indicator:**

This switch is used to turn the 850iR ON (switch up), or OFF (switch down). When the POWER switch is in the ON position, the POWER light will glow red.

2. IR Indicators (IR): These lights will glow red when the corresponding microphone is turned on. This light confirms the 850iR is receiving a steady infrared signal.

3. AF Indicators (AF): These lights flash green when audio (voice) from the microphone is detected.

4. A VOLUME: Controls the volume level of the teacher microphone that is switched to Channel A. Rotating the knob clockwise increases output level.

5. B VOLUME: Controls the volume level of the optional second microphone that is switched to Channel B. Rotating the knob clockwise increases output level.

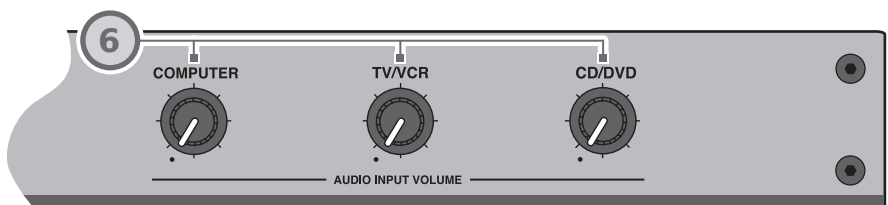
**6. AUDIO INPUT VOLUME:**

- **COMPUTER:** Controls the volume of audio coming from a computer connected to the rear panel COMPUTER INPUT jack.
- **TV/VCR:** Controls the volume of the source connected to the rear panel TV/VCR INPUT.

- **CD/DVD:** Controls the volume of the source player connected to the rear panel CD/DVD INPUT.

REAR PANEL CONTROLS

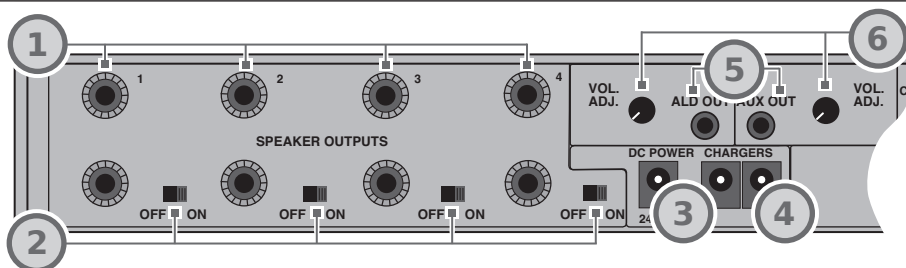

- 1. SPEAKER OUTPUTS (1-4):** These binding post connectors are used to connect the 850iR to the loudspeakers. Depending on the speaker package, all the outputs may not be used.
- 2. SPEAKER ON/OFF:** These individual speaker switches can be used to turn off the audio in a specific area of the classroom where there may be a learning group or quiet time.
- 3. DC POWER:** Plug the 24 V power supply into this jack.
- 4. CHARGERS:** These jacks can be used to charge the optional LightMic or handheld mic as an alternative to connecting them to the REDMIKE cradle charger.
- 5. ALD/AUX AUDIO OUT:** These output jacks send audio signal to external equipment such as a recorder or an assistive listening device like the LES-370 Personal FM System.
- 6. ADJ:** These controls adjust the output level of the audio being sent out of the receiver/amplifier via the ALD/AUX AUDIO OUT jacks.

PageFirst: Emergency Page Priority

This optional feature interfaces with an independent classroom paging system. When the page is broadcast, the system is muted, ensuring important and emergency school-wide messages are never missed.

How it works:

1. PageFirst sensor clip is hung around the lead wires attached to the in-room paging speaker.
2. The clip is hard-wired to the 850iR.
3. As a page is broadcast, the sensor clip detects the audio signal through induction and immediately mutes the 850iR.
4. When the page is over, the audio to the 850iR returns to normal.

(For full installation instructions refer to the install sheet included with the optional PageFirst sensor.)

REAR PANEL CONTROLS (cont'd)

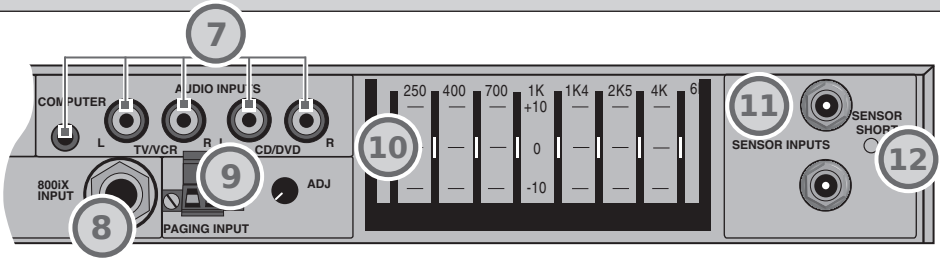

7. AUDIO INPUTS:

- **COMPUTER:** Accepts stereo signal from computer via 3.5 mm cable.
- **TV/VCR:** Accepts stereo signal from TV/VCR via RCA cable.
- **CD/DVD:** Accepts stereo signal from CD/DVD player via RCA cable.

8. 800iX INPUT: This input jack allows for interface with the Lightspeed 800iX wireless microphone system, which adds up to additional two microphone channels.

9. PAGING INPUT and ADJ:

When the optional PageFirst sensor is connected to this input, the audio being amplified through the 850iR will mute as an announcement is made through the school PA system, ensuring important messages are never missed.

10. 8-BAND GRAPHIC EQUALIZER:

The sliding controls adjust the levels of the various audio frequencies. This allows the installer to properly equalize the system to produce optimum sound quality.

11. SENSOR INPUT:

The IR sensor cable connects to either of these two inputs. Connect additional sensors to the 850iR to cover large or odd-shaped classrooms.

12. SENSOR SHORT:

This LED glows red when there is a short in the sensor or cable.

REDMIKE CONTROLS AND CONNECTIONS

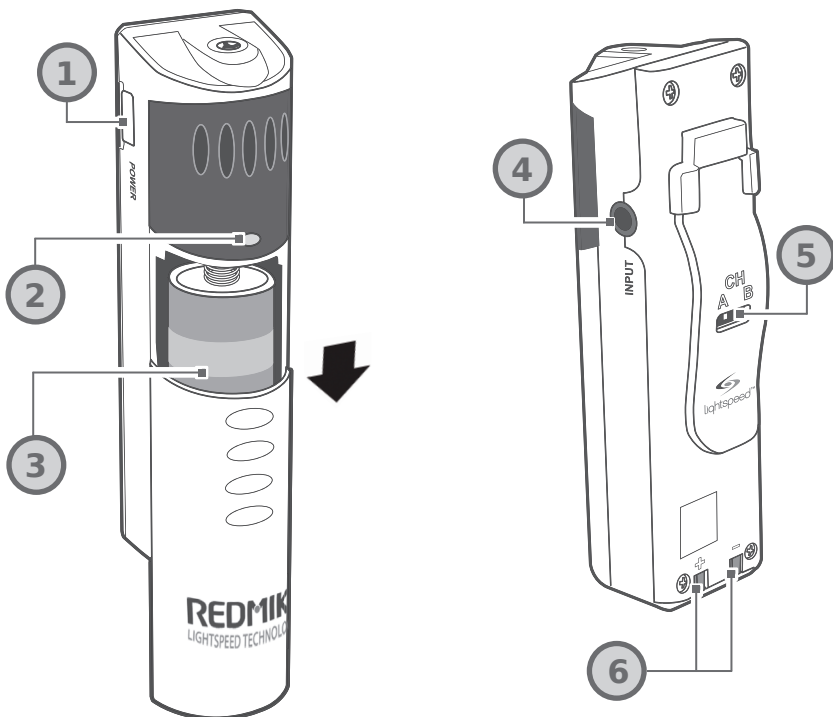

- 1. POWER BUTTON:** Press this button to turn the REDMIKE ON, press again to turn it OFF (mute).
- 2. POWER/LOW BATTERY INDICATOR:** A BLUE light indicates the REDMIKE is on and fully charged. A RED light indicates a charge is needed.
- 3. BATTERY COMPARTMENT:** To access the battery compartment, slide the door downward. The battery should only be replaced by a Lightspeed AA rechargeable sensing battery (part # BA-NH2A27).
- 4. AUDIO/MICROPHONE INPUT:** Use this input to plug in a laptop, MP3 player or other audio source to wirelessly transmit audio to be played through the system. Alternatively, an external microphone can be connected.
- 5. CHANNEL SELECT SWITCH (CH A/B):** This switch allows for selection between Channel A or B. If you are using a single microphone, we recommend using Channel A.
- 6. CHARGER CONTACTS (+ -):** These contacts interface with the charging tabs in the BC-RMCC cradle charger for daily charging. Simply place the REDMIKE in the charger.

ATTACHING THE LANYARD TO REDMIKE

1. ATTACH THE FOAM HOLDER

Insert the REDMIKE clip into the slot at the bottom of the foam holder.

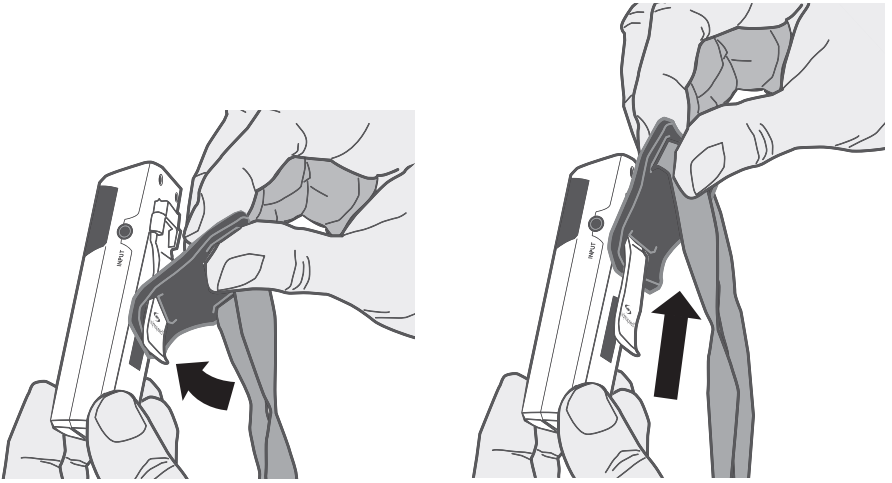

2. POSITION THE REDMIKE

Slip the REDMIKE with lanyard around the neck. Adjust the neck strap so the top of the microphone rests just below your collarbone.

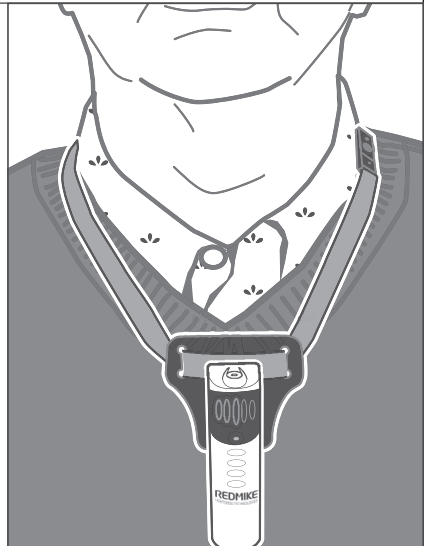

CRADLE CHARGER CONTROLS AND CONNECTIONS

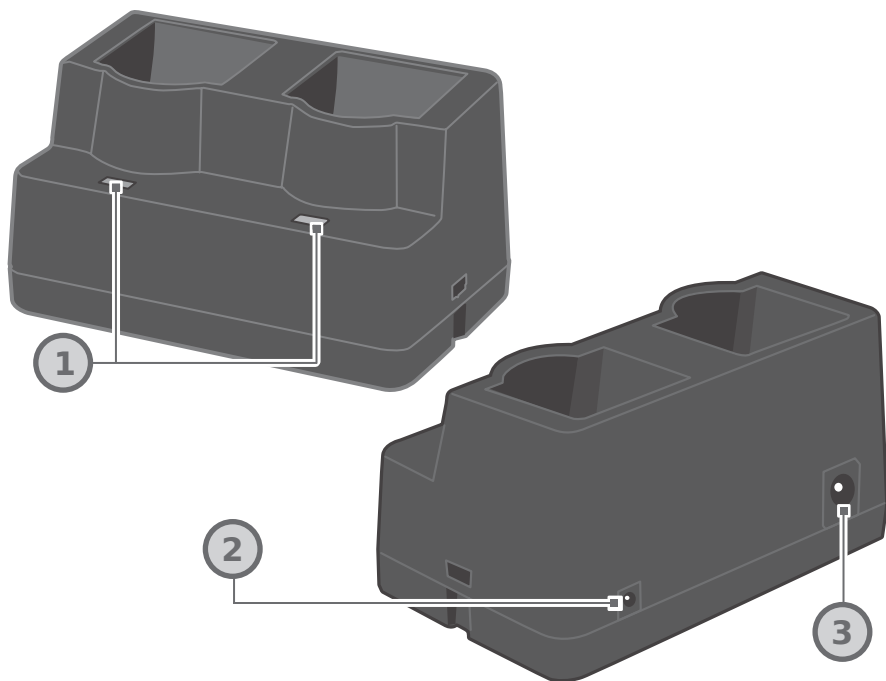

1. CHARGE INDICATORS: The light glows RED while the REDMIKE is charging. When fully charged, the light will glow GREEN.

2. DC POWER PORT: Connect the DC power cord here.

3. OPTIONAL CHARGING PORT: Plug the charging cord for the optional LT-71 or the HM-70 microphones here.

OPTIONAL LT-71 CONTROLS AND CONNECTIONS

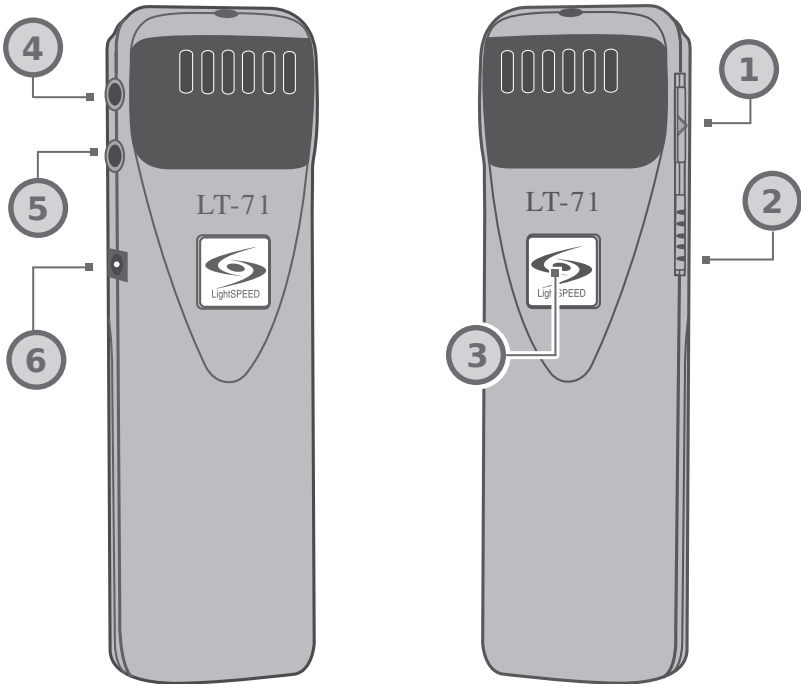

- 1. ON/OFF/MUTE Switch:** This switch turns LT-71 ON or OFF (mute).
- 2. Channel Select Switch (CH A/B):** This switch allows for selection of Channel A or B. If you are using a single microphone, we recommend using Channel A.
- 3. Power/Charge Indicator:** The light glows BLUE when the LT-71 is powered ON, RED when being charged.
- 4. External Microphone Input (MIC):** Use the 3.5mm MIC jack for the optional TK-250 headset microphone (part# MC-TK250LTM).
- 5. Auxiliary (AUX):** Plug a laptop, MP3 player or other audio source into this jack to wirelessly transmit the audio signal to be played through the system.
- 6. Charger Input (CHARGER):** Plug the charging cable from the charger into this jack for daily charging. The LED on the front will glow RED to indicate charging.

OPTIONAL HM-70 CONTROLS AND CONNECTIONS

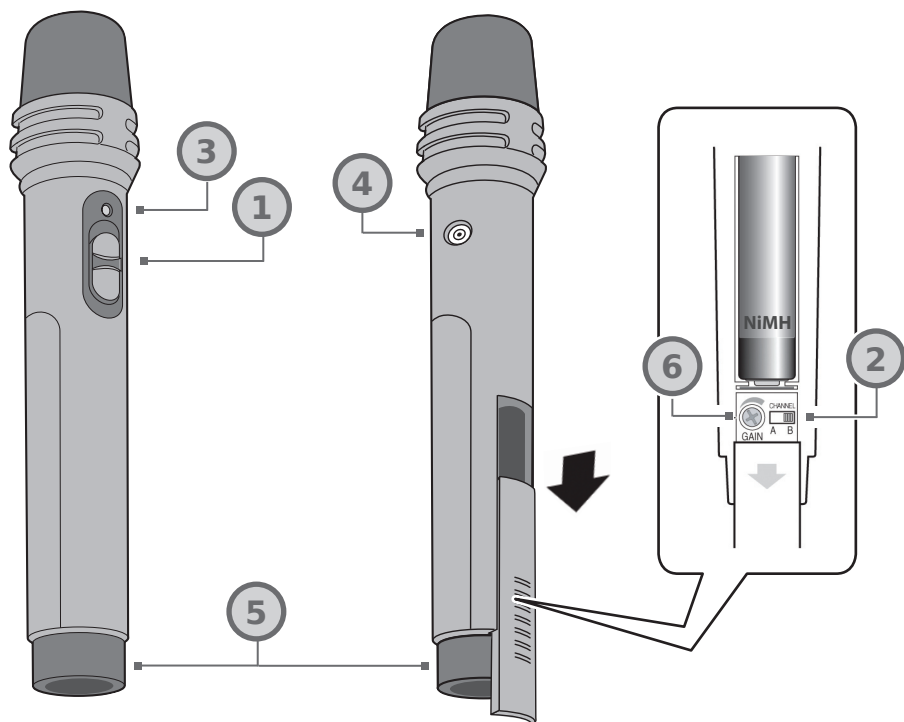

- 1. ON/OFF/MUTE Switch:** This switch turns the unit ON, OFF or MUTE.
- 2. Channel Select Switch (CH A/B):** Located in the battery compartment, the switch is set to Channel B at the factory.
- 3. Power/Charge Indicator:** The light glows RED when the HM-70 is powered ON, GREEN when charging.
- 4. Charger Input (CHARGER):** Plug the charging cable from the charger into this jack for daily charging.
- 5. Infrared Emitters:** Avoid covering the emitters as you grip the HM-70 as this could interrupt signal transmission from the microphone.
- 6. Volume Gain Adjustment:** Optimum volume level is pre-set at the factory and no adjustment should be necessary.

SECTION 2

Installation

1. UNPACKING YOUR SYSTEM

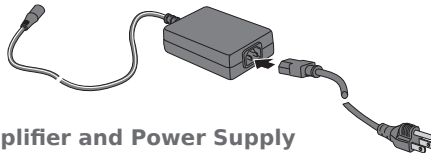
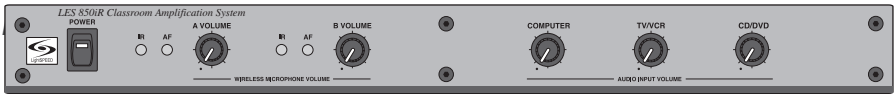

850iR Infrared Receiver/Amplifier and Power Supply

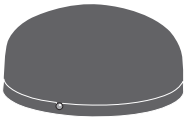

SR-70F Infrared Sensor and cable

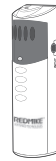

REDMIKE™ Classroom Microphone

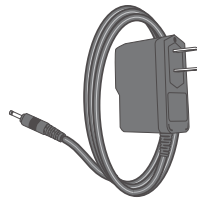
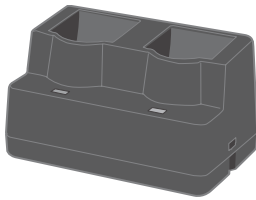

Charging Cradle and Power Supply

Speakers and Speaker Wire

Systems are configured with one of four speaker types shown to the right.

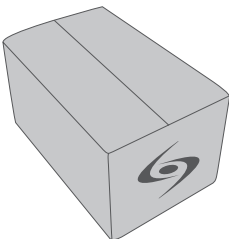

WMQ (x 4)



NXQ (x 1)



DRQ (x 4)

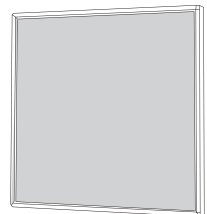

CNXQ (x 1)

2. LOCATION OF THE RECEIVER/AMPLIFIER

- Before running wires to the 850iR or plugging in, find a suitable, stable location for the amplifier. Ideally, the teacher should have ready access and an electrical outlet should be within six feet. The best possible location for the 850iR is in a media cabinet with any existing audio/video equipment.

Best

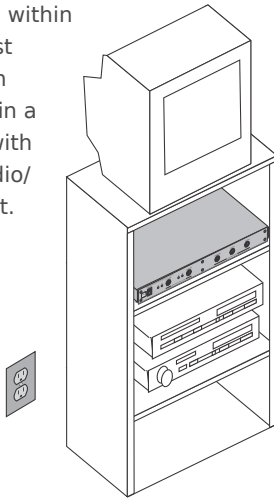

- A good location would be on any stable bookcase or shelf within 6 feet of an electrical outlet. The optional Lightspeed wall shelf (part #AC-800WB) is specifically designed to support the 850iR.

Good

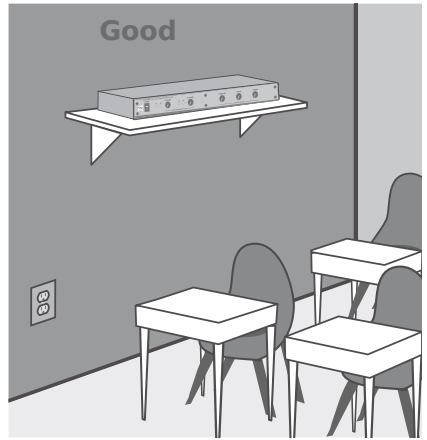

- **Wires** should be routed back directly to the amplifier, so select a location that is free from obstructions that may make routing wire difficult.

(Example: placing the 850iR near a whiteboard or bulletin board would require the wiring to be run an extra distance in order to reach the amplifier.)

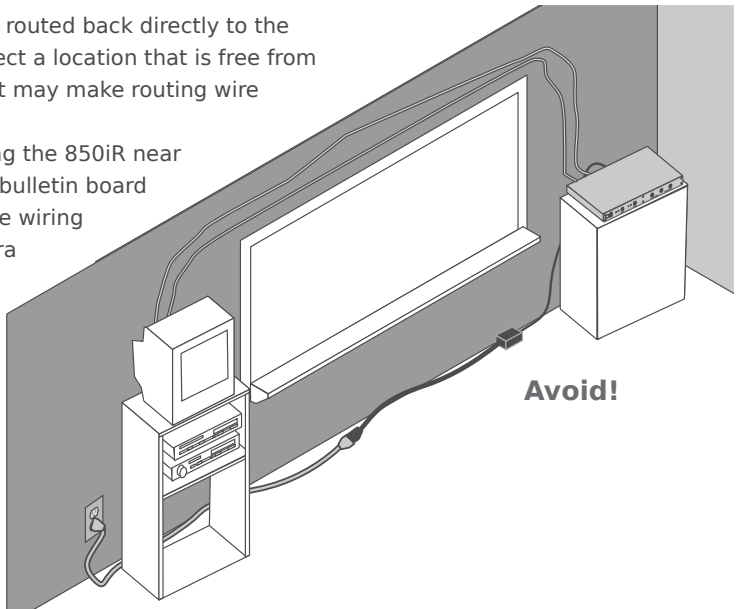

Avoid!

3. IR SENSOR INSTALLATION

Sensor location is very important for optimum performance of the 850iR Classroom Audio System.

- **BEST:** On the ceiling at or near the middle of the classroom.
- **GOOD:** High and centered on the long wall.
- **AVOID:** Locations in corners, on walls at heights lower than 7 feet, or in places where the line of sight is or could be obstructed.

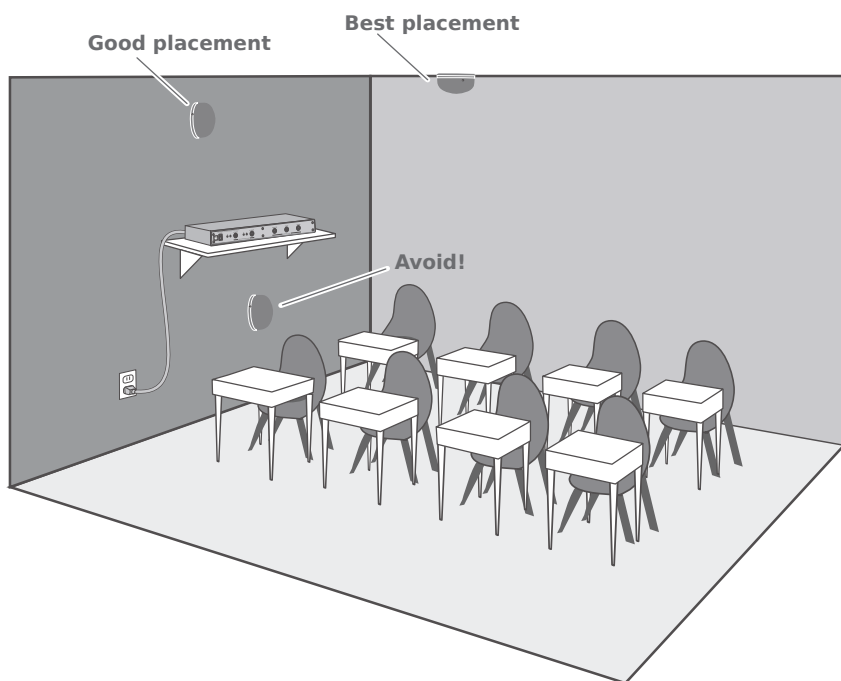

Helpful Hint

Before adjusting the graphic equalizer refer to the initial set-up on page 22. Sometimes fine-tuning is required to eliminate feedback.

Fine-tuning the Graphic Equalizer:

1. **Slide** up and flip down the EQ cover door.
2. **Walk** the room listening for feedback (squealing).
3. **Lower** the 2K5 and/or 4K sliders if a high-pitched ring is present.
4. **Lower** the 400 and/or 700 sliders if a low-pitched ring is present.
5. **Reduce** volume if feedback is still present.

IR SENSOR INSTALLATION (cont'd)

Suspended Ceiling Mount

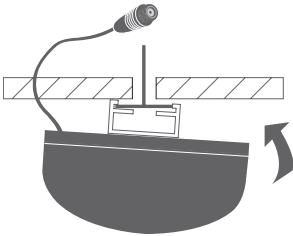

- 1. Lift** the ceiling tile nearest the grid rail in your desired sensor location. Guide one side of the C-clip over one edge of the grid rail. Providing firm support to the back of the grid rail with one hand (to prevent bending), firmly and carefully snap the second side of the C-clip over the edge of the rail.
- 2. Uncoil** sensor wire. Connect one end of the sensor cable to the plug on the sensor. Secure wire overhead and route it back to the system.
- 3. Connect** the other end of the sensor cable into one of the sensor inputs on the back of the system.

Wall/Solid Ceiling Mount

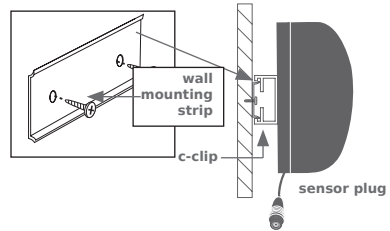

- 1. Screw** the plastic mounting strip to a place high on the wall or in the middle of the solid ceiling. Mount the strip horizontally as shown above.
- 2. Firmly** snap the C-clip on the back of the IR sensor onto the plastic mounting strip with the sensor plug hanging down (if a wall mount) or toward the receiver location (if ceiling mount).
- 3. Uncoil** the sensor wire. Screw one end of the sensor cable to the plug on the sensor. Route the wire back to the system, securing it along the way.
- 4. Connect** the other end of the sensor cable to one of the sensor inputs on the back of the system.

4. SPEAKER INSTALLATION

- 1. Locate** the speaker installation instructions packed with your speaker(s).
- 2. Follow** instructions and mount speaker(s).
- 3. Return** to this manual to complete the set up of your system.

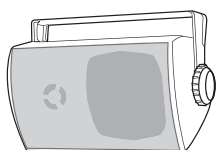

WMQ (x 4)



NXQ (x 1)

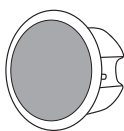

DRQ (x 4)

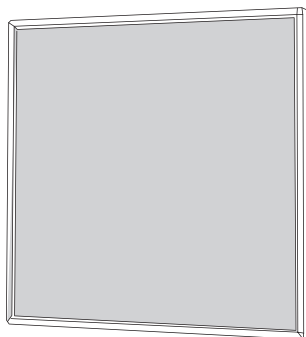

CNXQ (x 1)

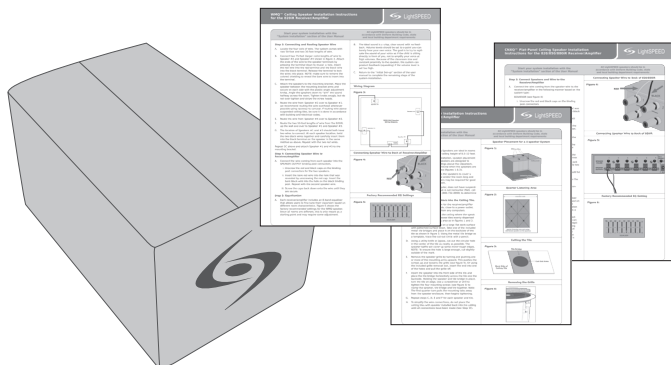

5. AUDIO INTEGRATION

850iR BLOCK DIAGRAM

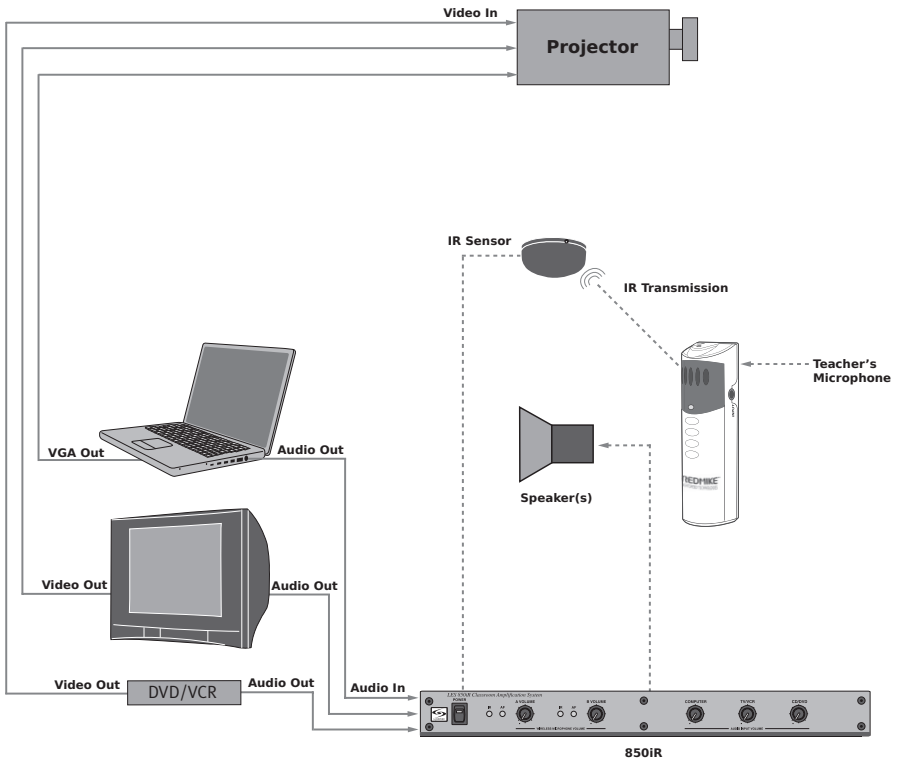

The 850iR is designed to integrate with multiple audio sources allowing other instructional technologies to be clearly heard throughout the classroom.

AUDIO INTEGRATION (cont'd)

Below are instructions on how to connect an external audio device like a TV/VCR, CD/DVD or computer directly into the 850iR.

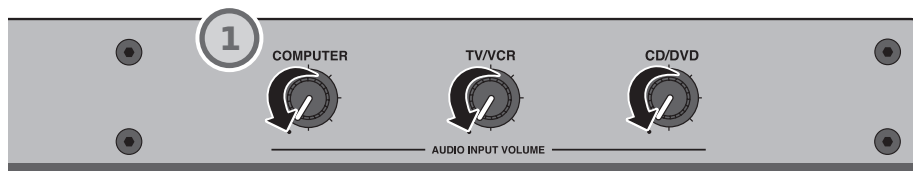

1. Turn the audio input volume controls on the front panel all the way down.

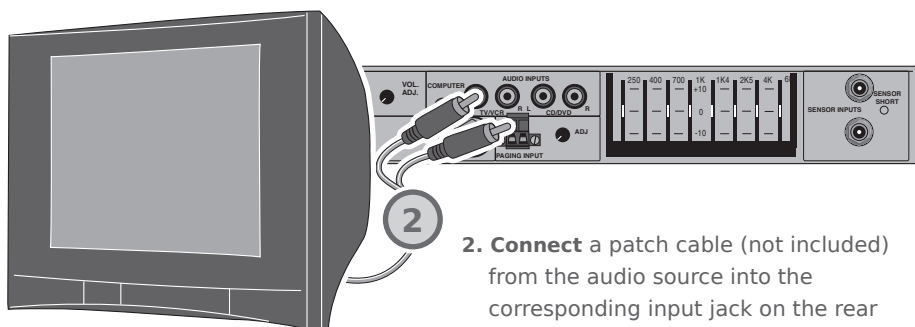

2. Connect a patch cable (not included) from the audio source into the corresponding input jack on the rear panel of the 850iR.

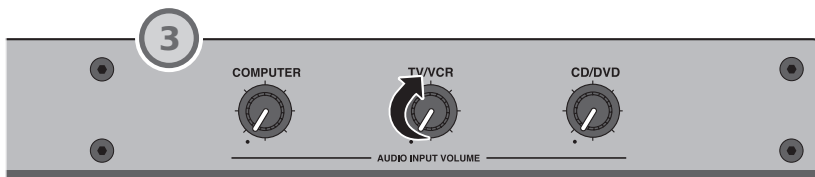

3. With both the 850iR and audio source power on, adjust the corresponding volume control until the desired level is achieved. **NOTE!** Be careful to not to set the volume too high, as this can distort the speaker and potentially cause damage.

6. FINALIZING CONNECTIONS

1. **Ensure** the power switch is in the “OFF” position and all front panel volume controls are turned fully counter-clockwise.



2. **Ensure** speaker wire connections are secure and not frayed. Under normal conditions, each speaker volume control should remain in the center position.

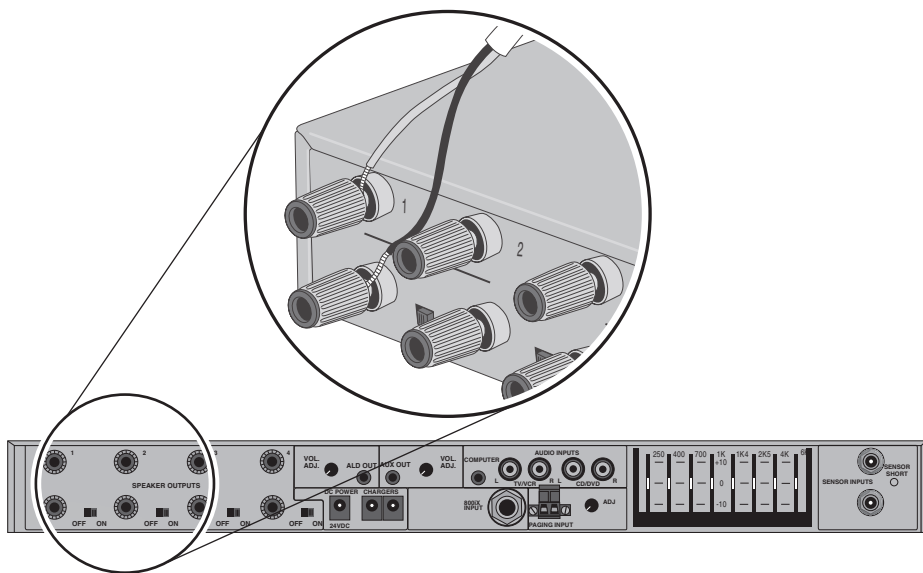

Helpful Hint

Use conduit to protect wires.

- **Conduit** is the best means to keep the wires/cables out of sight and safe from wear. (Conduit is not included.)

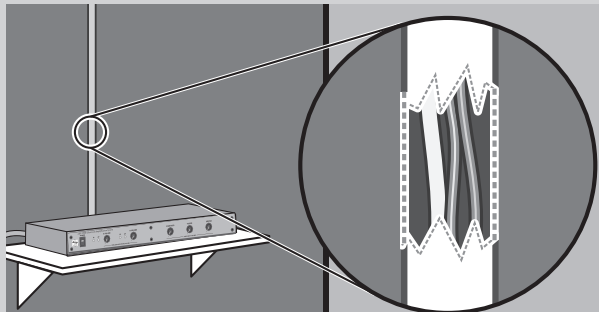

FINALIZING CONNECTIONS (cont'd)

3. Ensure any auxiliary audio sources are connected to corresponding labeled input.

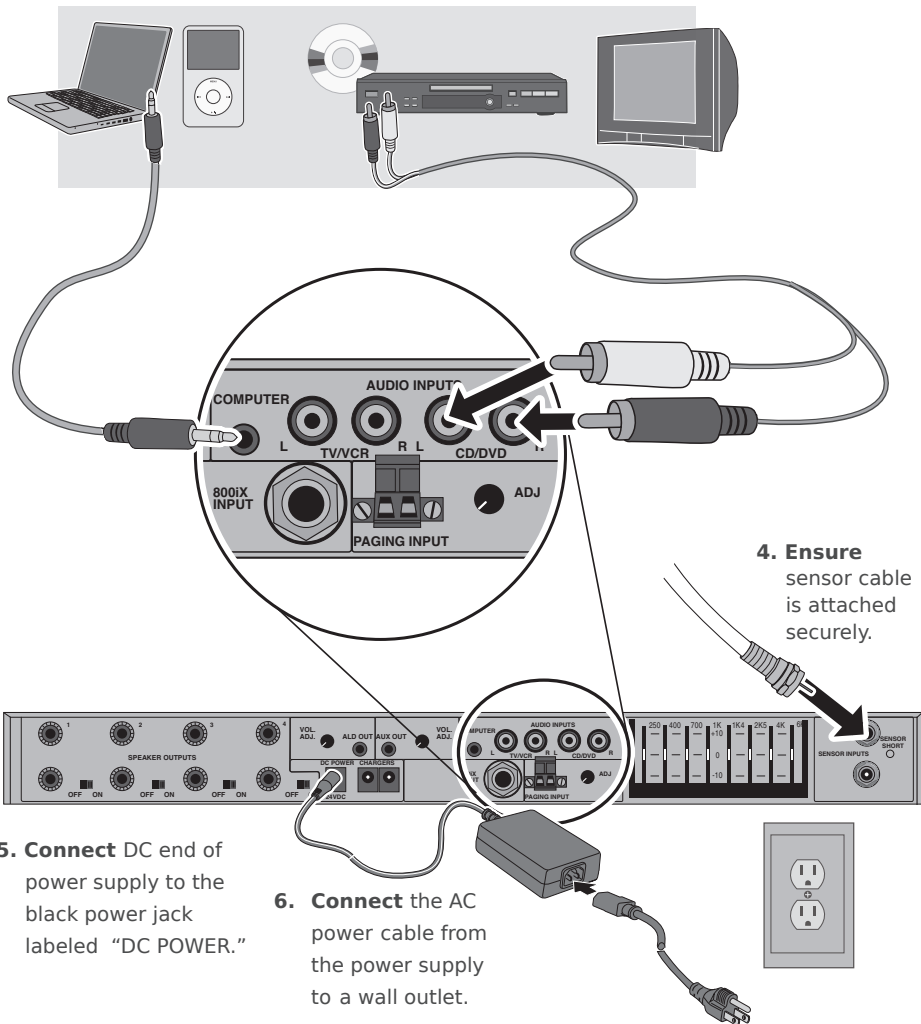

4. Ensure sensor cable is attached securely.

5. Connect DC end of power supply to the black power jack labeled "DC POWER."

6. Connect the AC power cable from the power supply to a wall outlet.

FINAL CHECK

- 1. Ensure** all cables are appropriately routed out of walking paths and work areas to prevent safety hazards to individuals in the room.
- 2. The amplifier** packing material should be kept for warranty shipping purposes.
- 3. Proceed** to initial set-up to test system performance.

*Leave microphones charging so they are ready for use.
Microphones will need to be charged on a daily basis.*

SECTION 3

Initial Set-up, Charging and Optional Features

INITIAL SET-UP: REDMIKE

- 1. Turn** the 850iR power switch to the ON position. The RED LED on the switch will glow.

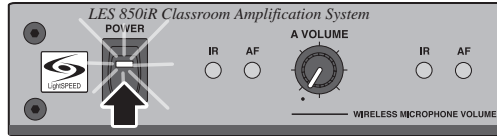

- 2. Turn** on the REDMIKE. The RED IR LED on the 850iR will light to indicate a signal is being received.

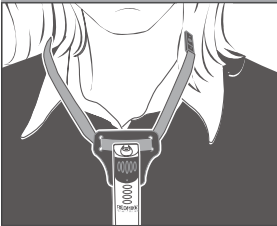
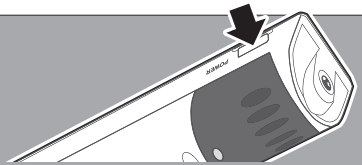

- 3. Slip** the REDMIKE with lanyard around the neck and position the top of the microphone just below the collarbone. **NOTE:** Positioning of the REDMIKE is critical for proper volume adjustment.

- 4. While** speaking in a normal voice slowly increase the volume of the corresponding channel on the 850iR until your voice is barely audible.

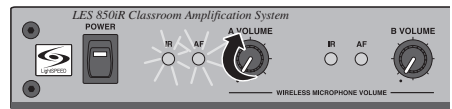

REMEMBER: This equipment supplements the user's voice so they are able to speak in a conversational tone. Having the volume set too high will result in feedback and listener fatigue.

- 5. Once** initial volume level is set, walk around the room and listen for audio dropout and overall audio quality. Fine-tuning the audio is accomplished by making minor adjustments to the 8-Band Graphic Equalizer on the back panel of the 850iR.

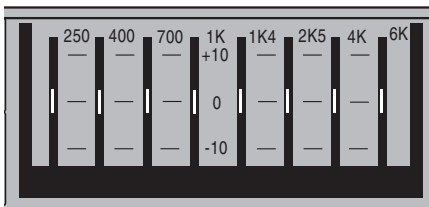

See page 13 for hints on setting the EQ.

- 6. If** a second REDMIKE was purchased, repeat steps 2-4. **NOTE:** Each REDMIKE has its channel pre-set to either A or B. No further adjustment is necessary.



INITIAL SET-UP: OPTIONAL LT-71

1. **Turn** the 850iR power switch to the ON position. The RED LED on the switch will glow.

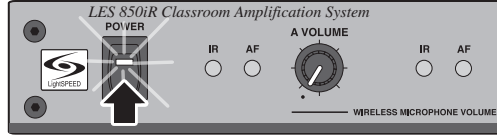

2. **Turn** on the LT-71 and set the operating channel to "B".

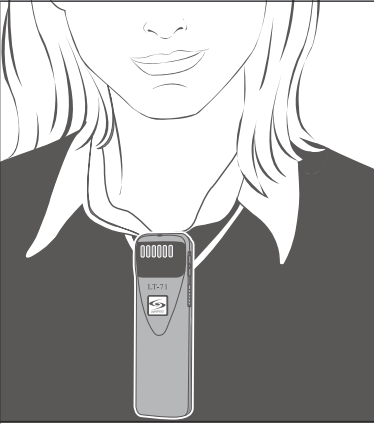
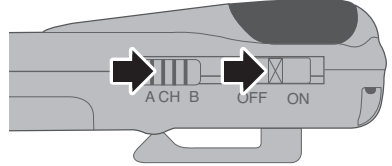

3. **Slip** the LT-71 with lanyard around the neck and position the top of the microphone just below the collarbone.
NOTE: Positioning of the LT-71 is critical for proper volume adjustment.

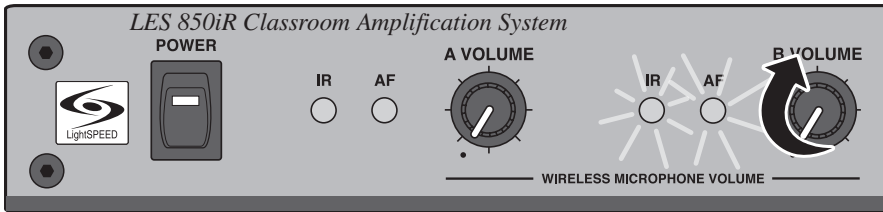

4. **While** speaking in a normal voice, increase the B VOLUME level until your voice is barely audible. **REMEMBER:** This equipment is designed to supplement and distribute the user's voice so they are able to speak in a conversational tone. Having the volume set too high will result in feedback and listener fatigue.

INITIAL SET-UP: OPTIONAL HM-70

- 1. Ensure** the 850iR is ON. The RED LED on the power switch will glow.

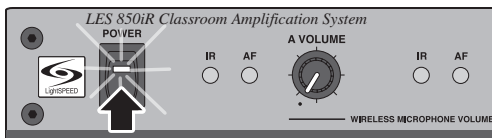

- 2. Turn** on the HM-70 by sliding the switch to the top position.

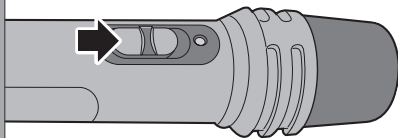

- 3. Grip** the barrel in the center section. Avoid covering the infrared emitters circling the base. This could interrupt signal transmission.

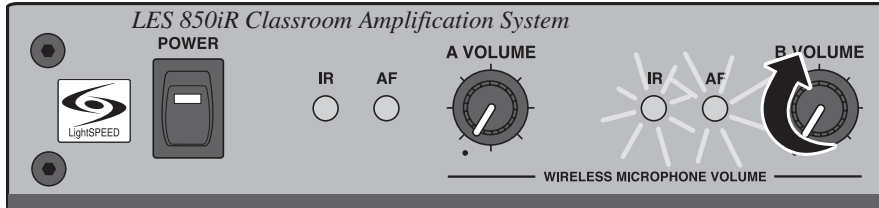

- 4. While** speaking in a normal voice, increase the B VOLUME level until your voice is barely audible. **REMEMBER:** This equipment is designed to supplement and distribute the user's voice so they are able to speak in a conversational tone. Having the volume set too high will result in feedback and listener fatigue.

CHARGING THE REDMIKE

- 1. Plug** power cord into the cradle charger and then plug the AC end into an electrical outlet.

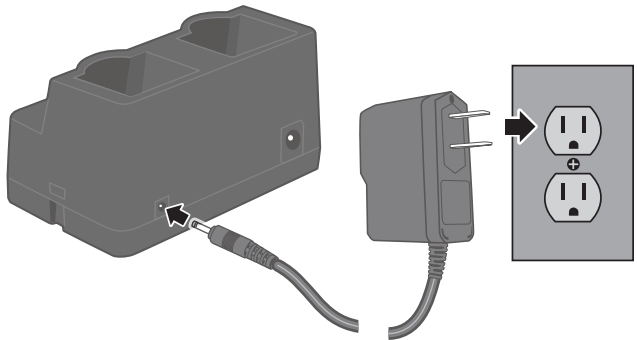

- 2. Ensure** that the REDMIKE is turned OFF.

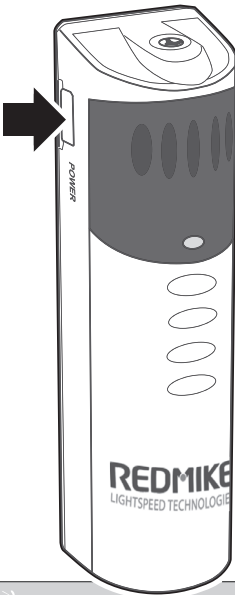

- 3. Place** the REDMIKE into the cradle. The LED on the cradle will glow RED indicating charging has started. When the REDMIKE is fully charged the LED on the cradle charger will change to GREEN.

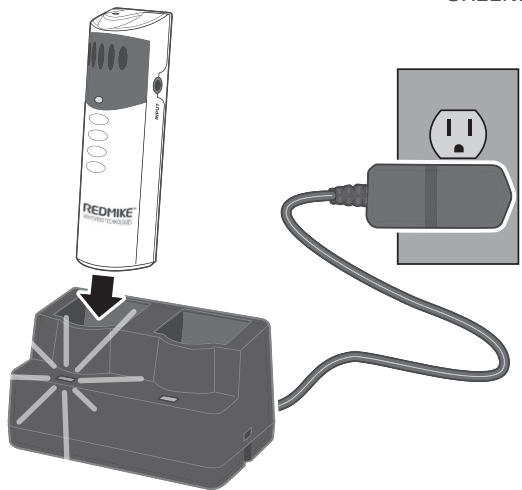

Helpful Hint

- REDMIKE incorporates alkaline protection into the microphone design. Replacement AA NiMH batteries may only be purchased through Lightspeed Technologies (part # BA-NH2A27).
- A blinking LED indicates a charging error. Be sure to use a Lightspeed rechargeable sensing battery.

CHARGING THE OPTIONAL LT-71

- 1. Ensure** that the LT-71 is turned OFF.
- 2. Make** sure the cradle charger is plugged into a wall outlet. Connect one end of the charging cable into the jack labeled CHARGER on the side of the LT-71 and plug the other end into the charging jack on the rear of the REDMIKE cradle charger. The LT-71's rechargeable batteries are factory installed. The LED on the front of the LT-71 will glow RED when charging.
- 3. Leave** the LT-71 plugged in overnight (8-10 hrs.) to obtain a full charge.

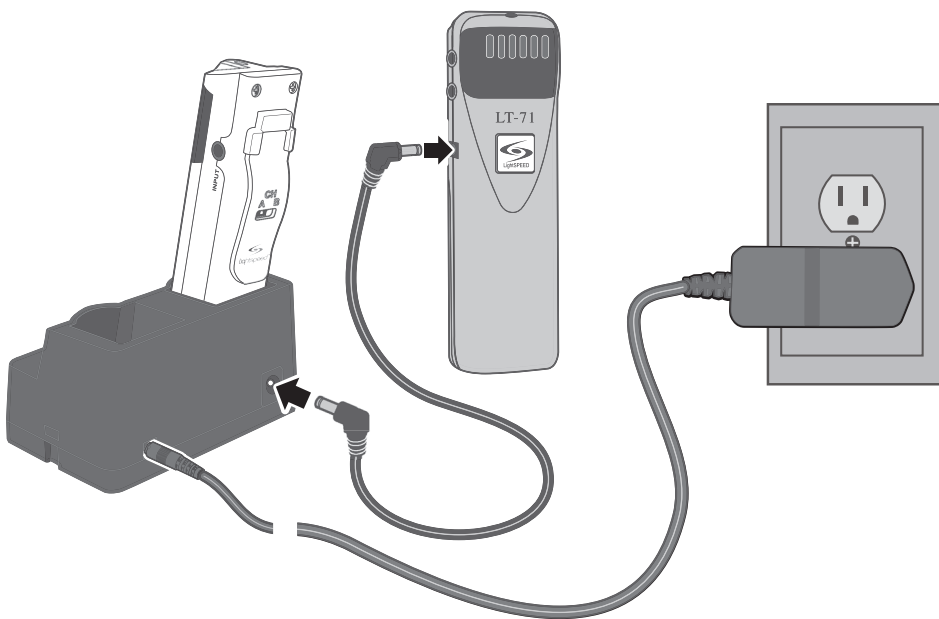

Helpful Hint

- Microphones can be left in the charger for up to two weeks without degradation to battery life.
- A full charge will be attained in 8-10 hours.
- Fully charged Lightspeed microphones will last over 7 hours.

CHARGING THE OPTIONAL HM-70

1. **Ensure** that the HM-70 is turned OFF.
2. **Make** sure the cradle charger is plugged into a wall outlet. Connect one end of the charging cable into the jack labeled CHARGER on the side of the HM-70 and plug the other end into the charging jack on the rear of the cradle charger. The HM-70's rechargeable batteries are factory installed. The LED on the front of the Handheld Mic will glow GREEN when charging.
3. **Leave** the HM-70 plugged in overnight (8–10 hrs.) to obtain a full charge. The GREEN light will turn off when fully charged.

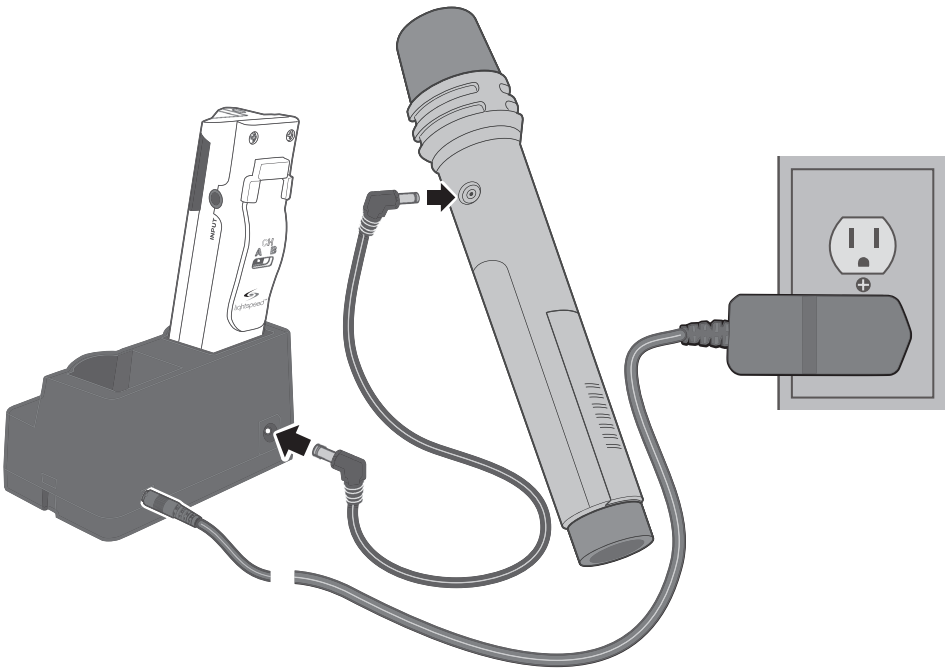

Helpful Hint

Do not attempt to charge alkaline batteries. They can overheat and expand, creating a significant hazard and damaging the LT-71 and HM-70. (This is not covered by the warranty.)

OUTPUT TO PERSONAL FM TRANSMITTER

1. **Turn** the ALD (Assistive Listening Device) volume control on the back panel all the way down (fully counterclockwise).

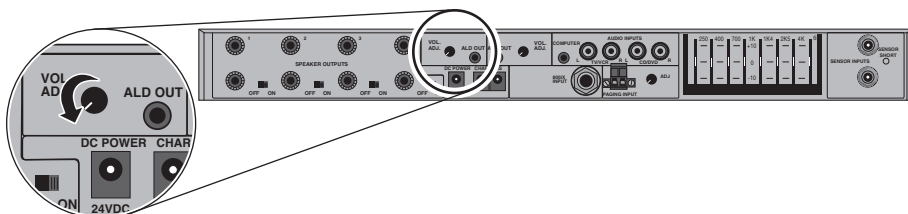

2. **Determine** the size and type of audio input jack on the device as many manufacturers' products differ in connector size and shape. The Lightspeed LES-370 Personal FM System requires a 3.5 mm to 3.5 mm patch cable (part# CA-MMC3535, not included).

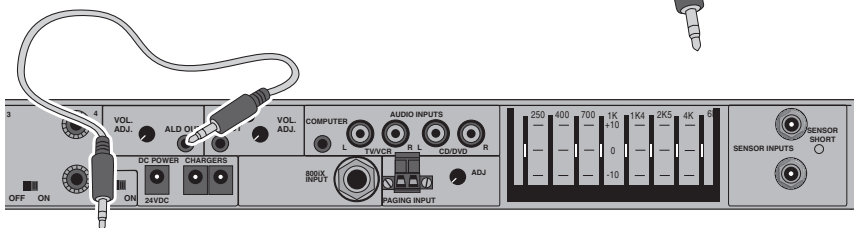
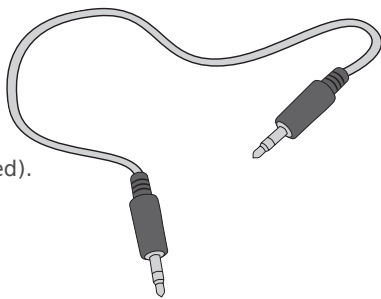

3. **Connect** a patch cable from the ALD's microphone jack or AUX input to the 3.5 mm audio jack labeled "ALD OUT" on the back of the 850iR.
4. **Adjust** the volume control on the ALD's receiver to maximum output. **NOTE!** This is to set the maximum allowable signal from the 850iR.
5. **With** the 850iR and ALD turned on, speak into the REDMIKE and slowly adjust the corresponding "ADJ" volume control until the appropriate audio level is attained in the ALD's receiver headphones.

USING THE REDMIKE TO AMPLIFY EXTERNAL AUDIO EQUIPMENT

The REDMIKE includes a 3.5mm audio input jack to connect to an audio source like a laptop or MP3 player. The REDMIKE will transmit the audio signal to be played through the system.

1. If your system includes two REDMIKEs, use the student microphone (already set to Channel B). **NOTE:** This feature works on both channels but we recommend using Channel B so the teacher's volume on the CH A does not have to be adjusted. **REMEMBER:** It's easy to determine which REDMIKE is set to Channel B by speaking into the mic and watching which set of LED's glow on the front panel of the 850iR.

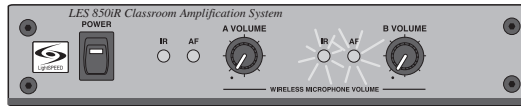

2. Plug your laptop, MP3 player or other audio source into the input on the REDMIKE labeled "INPUT" using a 3.5mm patch cable.

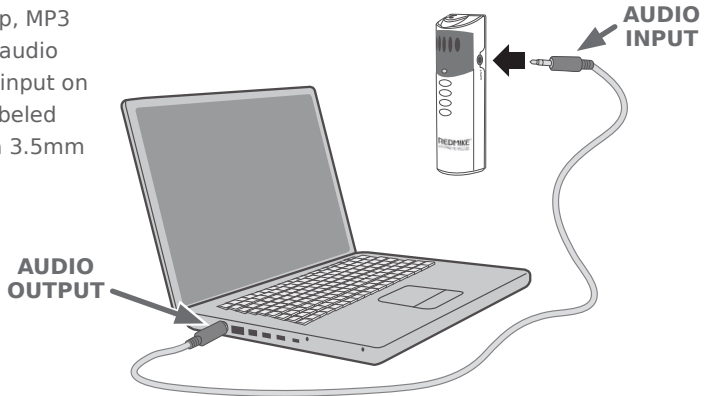

3. Adjust the volume of the selected mic channel to achieve desired loudness.

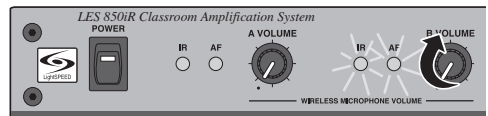

Helpful Hint

The optional LT-71 can also amplify external audio. Simply plug the 3.5mm patch cable from the audio source into the input labeled "AUX IN" and adjust the volume of the source to the desired sound level.

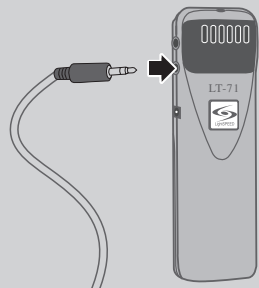

SECTION 4

Troubleshooting, Daily Use and Warranty

TROUBLESHOOTING GUIDE

Note: Most problems are directly related to low battery power. Please run through the "Battery Check" items first. For remaining troubleshooting, use known good, fully-charged batteries.

Battery Check

- **Confirm** batteries are charged each night.
- **Confirm** proper batteries are used. The REDMIKE requires the Lightspeed BA-NH2A27 rechargeable sensing battery for proper charging. The LT-71 & HM-70 require NiMH AA rechargeable batteries.
- **Make** sure the microphones are turned off while charging so a full charge is attained. Full charge will last eight hours.
- **Inspect** the battery contacts. Clean and adjust if necessary.

Hearing Static

- **Ensure** sensor is in optimum location (refer to sensor placement in manual). A single sensor will cover a 1600 sq. ft. enclosed classroom.
- **Ensure** that no other REDMIKE/LT71/HM70 is operating on the same channel.

Low Volume or Feedback

- **Ensure** microphone is positioned appropriately, just below the collar bone.
- **Check** volume level on the amplifier. If the volume is too high, feedback will occur. Adjust accordingly.

No Sound From Speaker

- **Turn** the 850iR on. Confirm that the POWER light located on the front panel switch is on.
- **Confirm** signal is being received at the 850iR. The IR signal light will be RED indicating a signal is being received.
- **Confirm** that REDMIKE is turned on. There will be a BLUE LED on the microphone to indicate it is powered on.

If you review these instructions and still have questions, write down the serial number and model number of your system and call Lightspeed Technical Services at 800.732.8999, 5 a.m. – 5 p.m., PST.

DAILY USE INSTRUCTIONS

1. TURN ON THE 850iR



Ensure the power is switched on.

2. POSITION THE REDMIKE

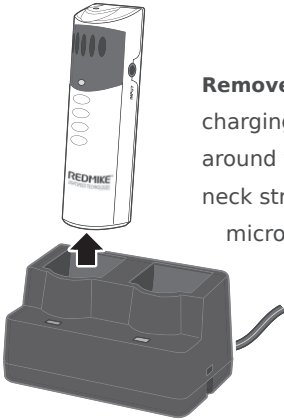

Remove the REDMIKE from the charging cradle and place it around your neck. Adjust the neck strap so the top of the microphone rests just below your collarbone.

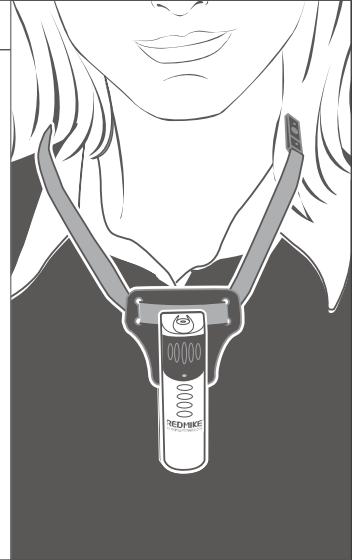

3. TURN ON THE REDMIKE

Turn the microphone ON using the ON/OFF switch on the side of the REDMIKE and speak normally.

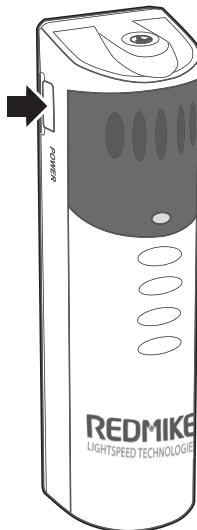

4. CHARGE BATTERIES

Place the REDMIKE back into the charging cradle to recharge at the end of the day.

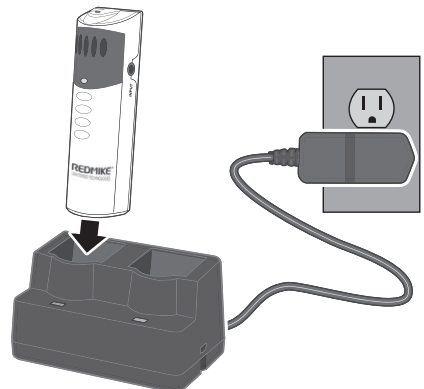

TIPS ON CLASSROOM AUDIO

1

Speak in a natural voice. A normal conversational speech level will provide an adequate signal. It is not necessary to increase the intensity of your voice—the audio system provides adequate amplification (approximately 5 – 10 dB) above ambient room noises.

2

Avoid wearing jewelry that may rub or bump against the microphone.

3

Turn the REDMIKE off during private conversations with a student, parent, or other classroom visitor. You can also cover the LED lens on top of the REDMIKE to block the signal.

4

Recharge batteries each night. When recharged nightly, operating time (actual usage) for the transmitters will last through a typical school day.

Five-year Limited Warranty

Lightspeed Classroom Audio Systems are guaranteed against malfunction due to defects in materials and workmanship for a period of FIVE (5) YEARS, beginning at the date of the purchase invoice. If such malfunction occurs, the product will be repaired or replaced (at Lightspeed's option) without charge during the warranty period.

1. Warranty on infrared microphones is FIVE (5) YEARS.
2. Warranty on Lightspeed rechargeable batteries, all external cables and wires provided by Lightspeed is one (1) year.
3. Prepaid shipping labels are provided by Lightspeed factory or an authorized warranty service center for warranty repairs.
4. Warranty does not extend to finish, appearance items, or malfunctions due to abuse or operation other than specified conditions, nor does it extend to incidental or consequential damages. Repair by other than Lightspeed or its authorized service agencies will void this guarantee. Information on authorized service agencies is available from Lightspeed Technologies, Inc.

**Our Service Department (800.732.8999, 5 a.m. – 5 p.m., PST)
will handle all your repair/replacement needs.**

SYSTEM SPECIFICATIONS

OVERALL SPECIFICATIONS

Power Output	12 W per channel (48 W total)
Amplifier Frequency Response	40 Hz to 20 kHz \pm 3 dB
Carrier Frequencies (IR)	2.06/2.54; 3.2/3.7 MHz
Signal-to-Noise Ratio	> 73 dB
Dynamic Range	> 73 dB
Maximum Deviation	\pm 50 dB

RECEIVER SPECIFICATIONS

Receiver Type	Superheterodyne
Receiver Sensitivity	6 μ V for 60 dB S/N
Image and Spurious Rejection	> 70 dB
Dimensions (W x D x H)	17.3" x 8.5" x 1.75"
Weight	7 lbs.

TRANSMITTER SPECIFICATIONS

REDMIKE

Audio Distortion	< 1 %
Built-in Microphone	Unidirectional Electret
Battery Power (1-year warranty)	1 AA NiMH Rechargeable Sensing Battery
Audio Input	3.5 mm
Dimensions (W x D x H)	0.9" x 1.0" x 3.5"
Weight	2.1 oz.

LT-71 LightMic

Audio Distortion	< 1 %
Built-in Microphone	Unidirectional Electret
Battery Power (1-year warranty)	2 AA NiMH Rechargeable
Audio Inputs	Mic Level 3.5 mm Line Level 3.5 mm
Dimensions (W x D x H)	1.375" x .75" x 4.625"
Weight	3.7 oz.

HM-70 Handheld Microphone

Audio Distortion	< 1 %
Built-in Microphone	Unidirectional Electret
Battery Power (1-year warranty)	2 AA NiMH Rechargeable
Dimensions (W x D x H)	2.25" x 2.25" x 8.75"
Weight	7.36 oz.

IR SENSOR SPECIFICATIONS

Working Range	Up to 1600 square feet per sensor
Cable	50 ft., Plenum-rated
Mounting	Ceiling clip/Wall bracket
Dimensions	4.25" (Diam.) x 2.0" (H)
Weight	4.5 oz.

INDIVIDUAL COMPONENTS & OPTIONAL ACCESSORIES

Part Number	Description
RX-850	Infrared receiver/amplifier/mixer
PS-24V-2.5	Power supply/battery charger for 850iR
IR-SR70F	Infrared sensor with cable and wall or ceiling mounting bracket
CA-PC50F	Plenum sensor cable (50 ft.)
RMT	REDMIKE classroom microphone w/lavaliere cord and rechargeable AA battery
BA-NH2A27	Lightspeed AA rechargeable sensing battery (for REDMIKE)
AC-RMLC	Lavaliere cord for REDMIKE
BC-RMCC	REDMIKE cradle charger
PS-5V-1.0	Cradle charger power supply
SPEAKERS	Contact Lightspeed at 800.732.8999 for speaker information
Optional Accessories	
LT71	LightMic microphone with lavaliere cord, rechargeable batteries and charging cable
HM70	Handheld microphone with rechargeable batteries and charging cable
MC-TK250LTM	Noise-canceling headset microphone
AC-TCC7	Charging cable for LT-71 and HM-70 microphones
AC-800WB	Wall shelf
CA-RCA6	6' dual RCA audio cable
CA-RCA24	24' dual RCA audio cable
CA-MSC3535	3.5mm to 3.5mm stereo audio cable
CA-MMC2535	Audio patch cable (2.5 mm mono to 3.5 mm mono)

USER NOTES

Record your system serial numbers and purchase information. This is helpful when ordering additional components, accessories, and/or warranty service.

Components	Serial Number
850iR	
Microphones	
Sensors	
Speakers	
Purchase Information	
Your School/Organization	
District	
Purchase Date	
Invoice	

MN0044US0112



Lightspeed Technologies, Inc.
11509 SW Herman Rd
Tualatin, OR 97062
800.732.8999
www.lightspeed-tek.com

